

CONTENTS

<i>Introduction</i>	3
General	3
System demands	3
<i>Load e-Cad (AutoCAD users)</i>	4
AutoCAD R14	4
AutoCAD 200X	5
<i>Start up e-Cad</i>	5
Under Windows	5
Under AutoCAD	5
<i>Open a project file</i>	6
<i>Open from server</i>	6
<i>Program sections</i>	7
Project	7
Unit	9
Layers	10
<i>Export DXF- file</i>	11
<i>Import AutoCAD block (for AutoCAD users)</i>	11
<i>Create an e-Cad button (AutoCAD users)</i>	12

Introduction

General

e-Cad is an application that is used to import Fläkt Woods's air handling units into AutoCAD drawings or to export DXF files from the selection program.

The e-Cad program takes data from the project file created by the selection program.

e-Cad can either be run as a stand-alone windows program or from AutoCAD. In both systems you have the possibility to create a 'dxf' file that can be interpreted by most Cad systems on the market.

If you run the program under AutoCAD you can also import AHU drawings direct from the project database to your current drawing.

System demands

Windows version (DXF-output) works on any Windows platform.

AutoCAD version requires the same platform as applicable AutoCAD version.

E-Cad has no special system requirements. E-Cad works on every modern computer.

Project files created by the EU2000/EC 2000 selection programs version 4.0.0/5.0.0 or later.

To use air handling units configured in ACON your computer needs to be properly connected to the Internet.

For direct connection from e-Cad AutoCAD R14 or AutoCAD 200X is required.

Load e-Cad (AutoCAD users)

For each session of AutoCAD the e-Cad program must be loaded. To make this easier, an e-Cad button can be created. See chapter *Create e-Cad button*

AutoCAD R14

Type *apload* on AutoCAD's command line or pick "load application" from the tools menu. The following dialogue window opens:

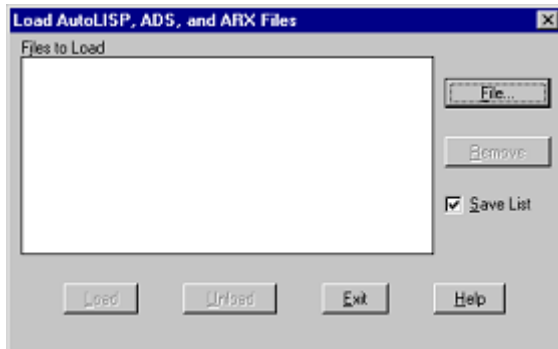

Fig. 1.

Make sure check-box *Save list* is checked. Click the file button and the following dialogue opens.

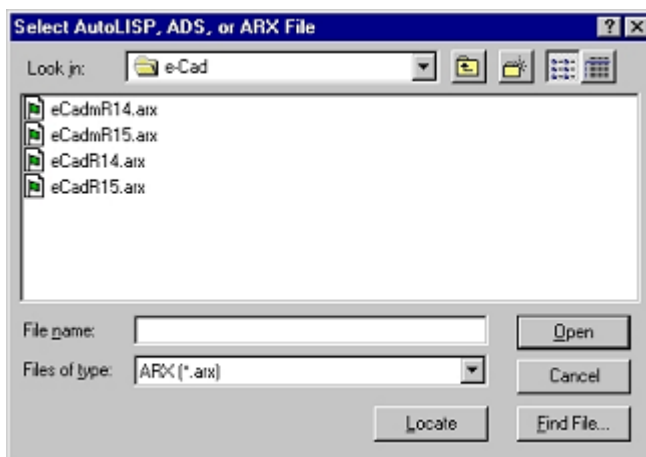

Fig. 2.

Change the file format to ARX(*.arx). Find the directory where e-Cad is installed (normally C:\PROGRAM\FLE\E-CAD). Mark the file "ecadr14.arx" and click the "open" button. The previous dialogue is now displayed with that file. Mark the file and click the "Load" button. e-Cad is now ready to run.

Next time you run AutoCAD the file will be in the Files to load list. Just mark it and click "load"

AutoCAD 200X

Type *appload* on AutoCAD's command line or pick "load application" from the tools menu. The following dialogue window opens:

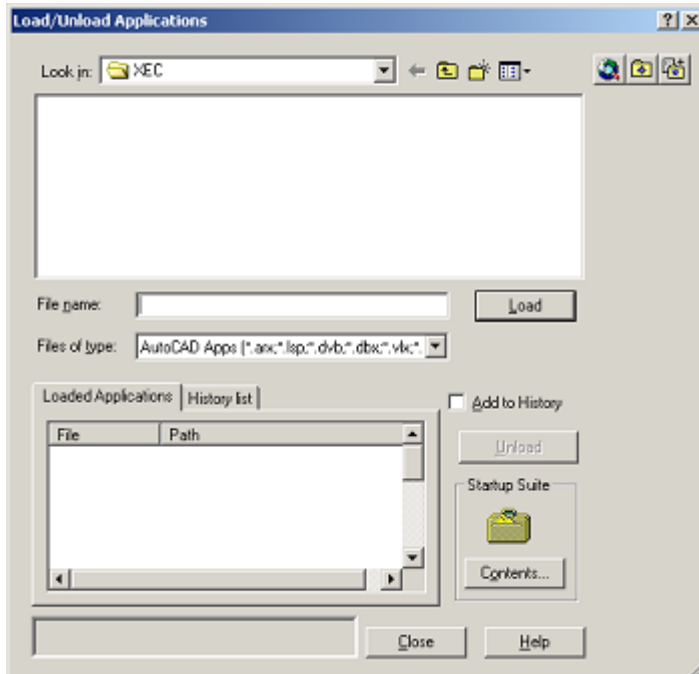

Fig. 3.

Make sure check-box *Add to history* is checked. Change the file format to ARX(*.arx). Find the directory where e-Cad is installed (normally C:\PROGRAM\FLE\E-CAD). AutoCAD 2000 and AutoCAD 2002 mark the file "Ecadr15.arx". AutoCAD 2004 mark the file "Ecadr15.arx". Click the Load button and e-Cad is now ready to run.

Next time you run AutoCAD e-Cad will be found under the history list.

Start up e-Cad

e-Cad can be run as a stand-alone Windows program or under AutoCAD.

Under Windows

To start the program select "Program" from the Start menu and then choose "e-Cad" under "FläktWoods Airhandling".

Under AutoCAD

Type `FLAKT_ECAD` on the command line and press *Return*. e-Cad starts. (you have to load the first time – see above)

Open a project file

From the e-Cad File menu select “Open...”

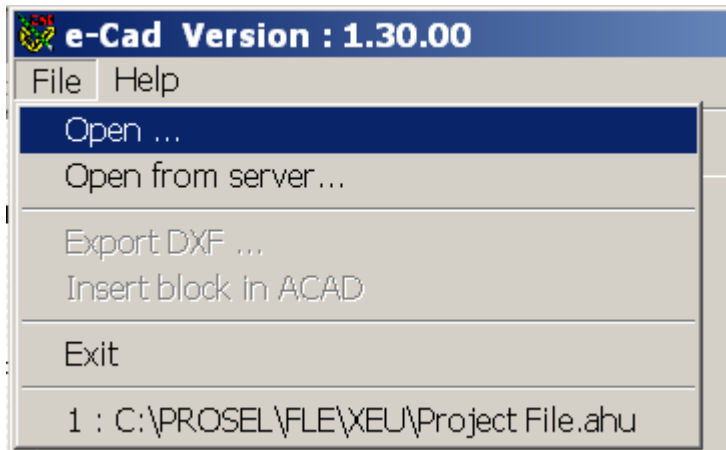

Fig. 4.

A dialogue box opens that allows you to find the project file you want. The project file that e-Cad uses has extension *.AHU. Previously used project files are listed at the bottom of the File menu and can be picked from there.

Open from server

From the e-Cad File menu select “Open from server...”

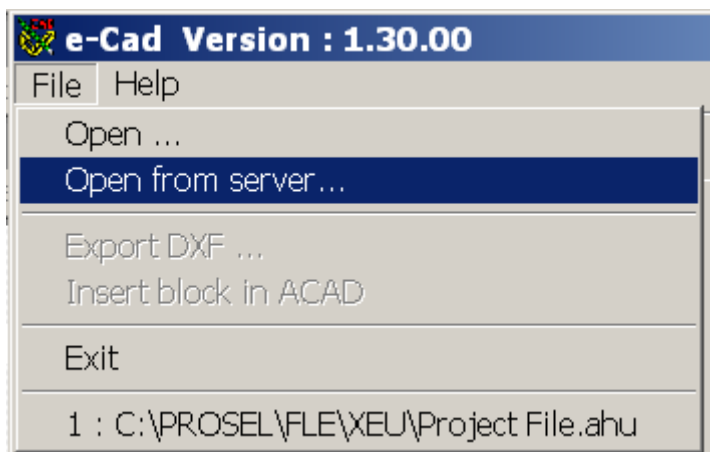

Fig. 5.

A Logon to server dialog will appear:

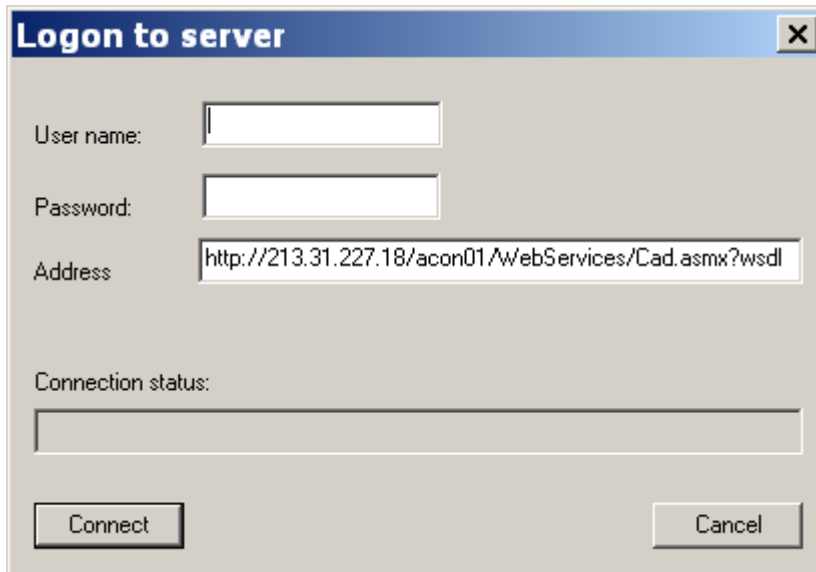

Fig. 6.

Enter your user name and password and click on the button “Connect”. The Address field should never be altered.

Program sections

e-Cad has three sections: *Project*, *Unit* and *Layers*. Under the *project* section you pick the project that you want to work with. (Note that the selection program allows unlimited project files to be created in each of which a number of projects can be stored. Each project can have a number of air handling unit selections stored)

Under *unit* you pick the air handling unit that you want and you choose the view that you want. The *Layers* section has the layer management.

Project

Click the combo-box Project ID to see all of the projects stored in the project file. (Of course there may only be one!)

When you pick a project you will see information for that project.

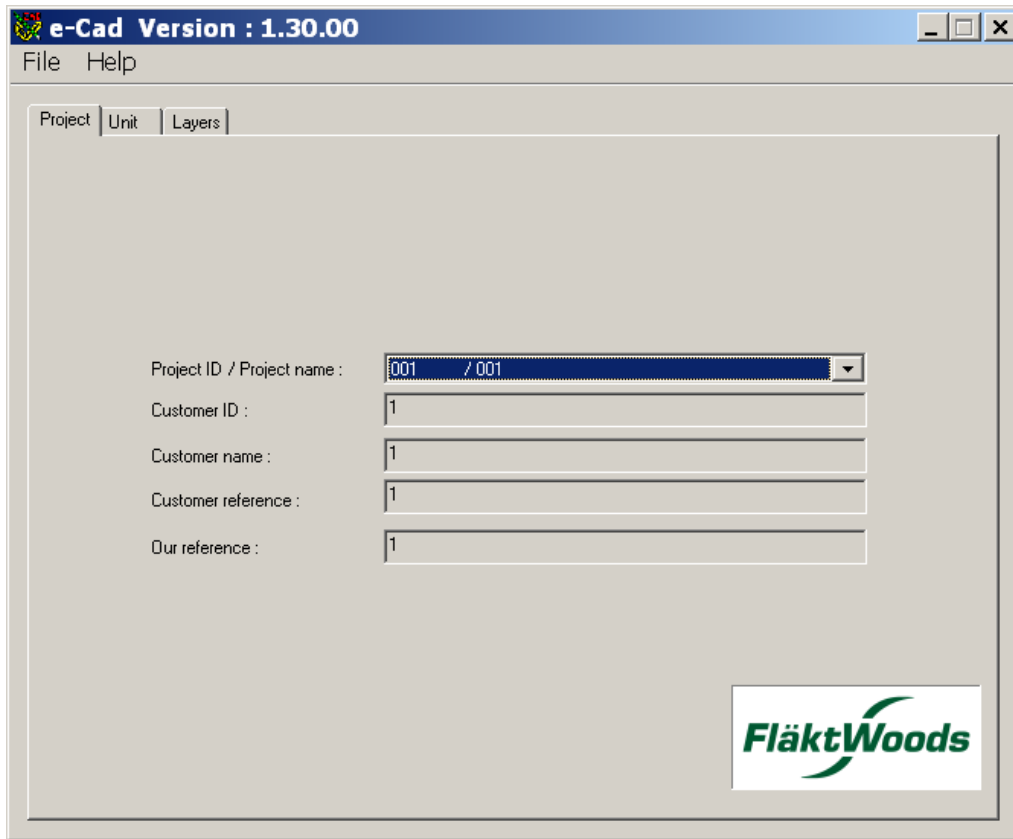

Fig. 7.

Unit

Click the combo-box Unit ID/Unit name to see the units and select the one you want. In the Viewpoint frame you can select the view you want and a preview of the drawing is shown. The 3-D view is a complete model of the unit and after import to the CAD drawing can be rotated freely. The 2-D views show only that elevation you have selected. You can also decide how much detail shall be included in the *Details* frame.

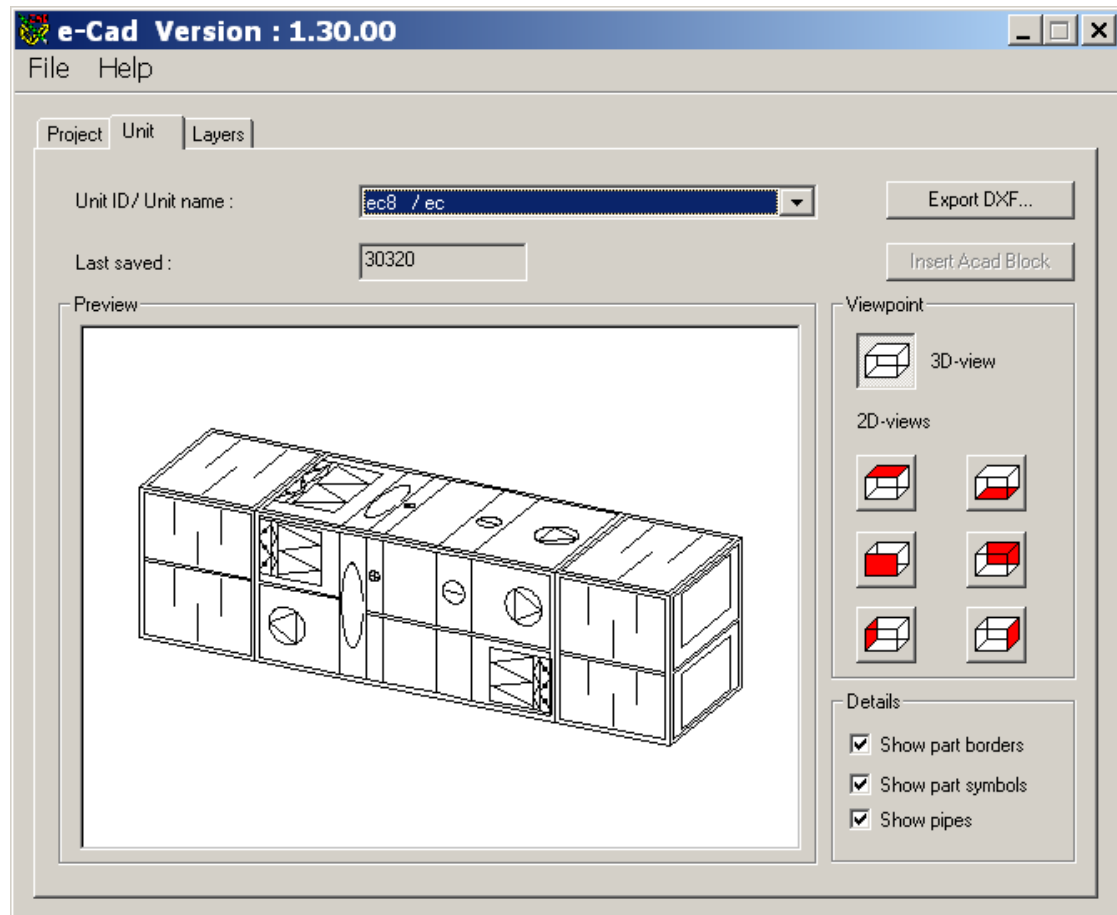

Fig. 8.

For explanation of the buttons Export DXF... and Insert Acad Block see specific chapters.

Layers

Here you can specify which layers the different AHU drawing components will lay in. The layer names you use here will automatically be transferred to AutoCAD. You can also choose the layer colour if you click on the colour box. It is even possible to define your own colour.

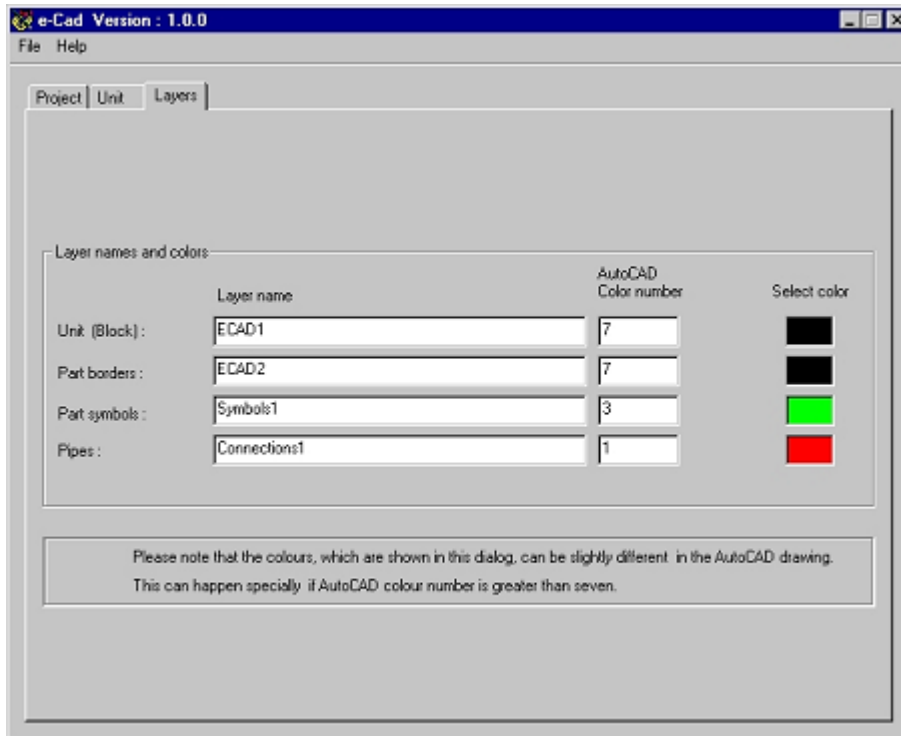

Fig. 9.

Export DXF- file

A DXF file (**Drawing Exchange File**) is an ASCII file describing the drawing and is used to pass drawings between different programs. Not only CAD systems but also some other programs such as Microsoft Word and PowerPoint can also import DXF files. Go to the section *Unit* and click the “Export DXF...” button. The following dialogue box opens.

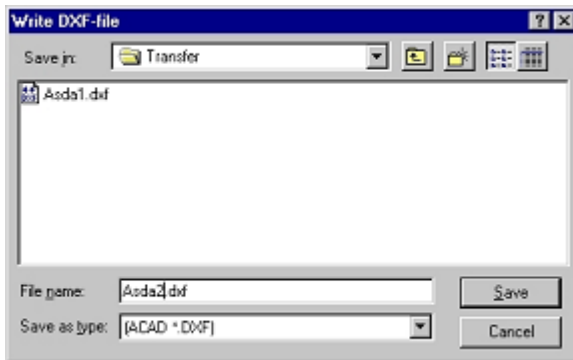

Fig. 10.

Decide on a suitable file name and the directory where you want to save it. The file will be given extension *dxf*.

Import AutoCAD block (for AutoCAD users)

Go to the section *Unit*. Click the button “Insert Acad Block”. Find and mark the insertion point on your drawing. Rotate the unit as you require. If there are separate supply and extract units then you will need to position both of them independently. All imported blocks are scaled with exact dimensions.

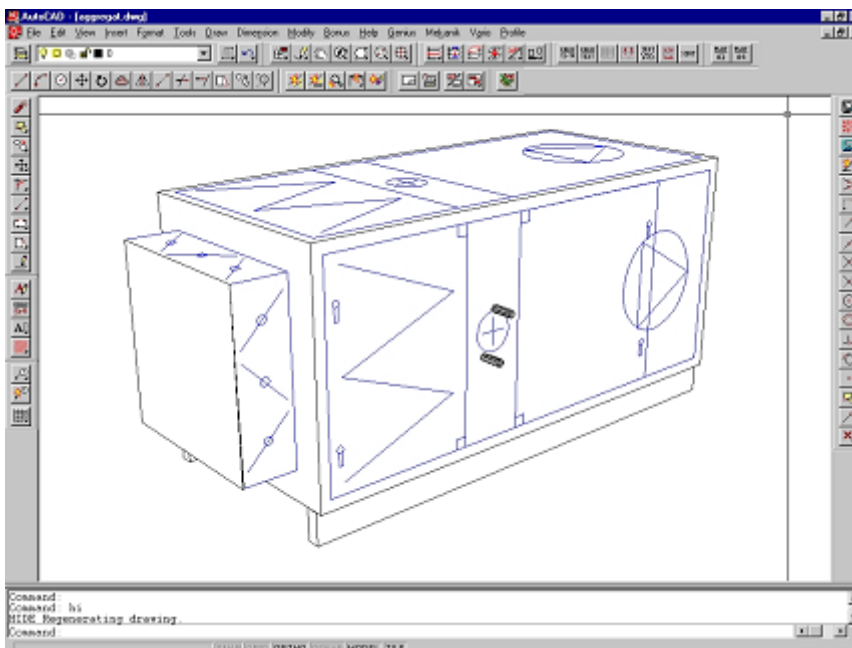

Fig. 11.

Create an e-Cad button (AutoCAD users)

To save you the bother of having to load e-Cad each time you start AutoCAD we recommend that you create an e-Cad button.

AutoCAD R14: Choose “Preferences” from the “Tools” menu or type Preferences on the command line. Go to the Files section.

AutoCAD 200X: Choose “Options” from the “Tools” menu or type Options on the command line.

Open “Support File Search Path” by clicking on the plus sign. Click “Add” and then “Browse”. Find the directory where e-Cad is installed (normally C:\PROGRAM\FLE\E-CAD) and click OK.

If you are advised to restart your computer then do that! After re-start continue with the next line (“Customize menus”).

Choose “Customize menus” under the Tools menu or type “menuload”.

In the dialogue box that opens go to the section Menu Groups.

AutoCAD R14: Click the “Browse” button and find the file “ecadr14.mnu” and open it.

AutoCAD 2002 or AutoCAD 2002: Click the “Browse” button and find the file “ecadr15.mns” and open it.

AutoCAD 2004: Click the “Browse” button and find the file “ecadr16.mns” and open it.

Click the button “Load”. Now the e-Cad button, as seen below, will be added to your AutoCAD buttons.



Fig.12.

Now all you have to do is click this button to load and run the e-Cad program.